

16 Megapixel Color Day/Night High Definition Professional IP Camera

From Puls Limited
www.puls-ltd.co.uk

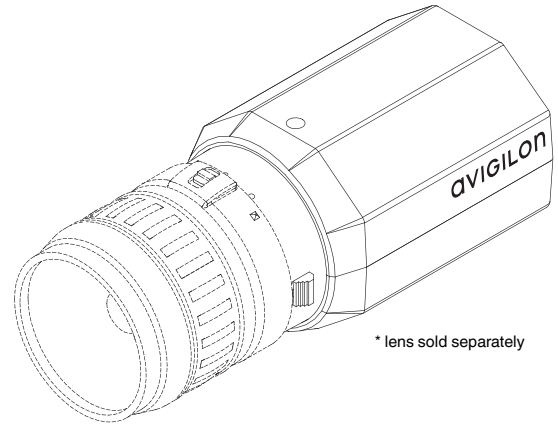

Description

The Avigilon 16 megapixel color day/night high definition professional IP camera is a high sensitivity, wide dynamic range, progressive scan CCD camera designed for the most demanding surveillance applications. It transmits images over 100BASE-TX or gigabit Ethernet using advanced JPEG2000 progressive compression technology to achieve the lowest network bandwidth and most efficient image storage in the industry while maintaining unsurpassed image quality.

The camera's advanced image acquisition system automatically adjusts the exposure time and the iris to ensure all available evidence is captured throughout the full range of day and nighttime scenes. The camera has an EF lens mount that is compatible with a wide selection of Canon® lenses.

The camera seamlessly integrates with Avigilon Control Center NVMS and High Definition NVRs using standard network equipment creating a network based surveillance solution with unmatched performance, ease of use, and ease of installation. Camera power is provided by either Power over Ethernet, 12 VDC, or 24 VAC.

Features

- 16 megapixel progressive scan CCD sensor
- Unsurpassed image quality
- 3 images per second at full resolution and 10 images per second at 4872 x 480
- 65 dB true dynamic range
- 0.1 lux minimum illumination
- Lossless JPEG2000 compression
- 35 mm optical format
- Automatic exposure control and iris control
- Software focus control
- Compatible with a wide selection of Canon® EF mount lenses
- Power over Ethernet, 24 VAC or 12 VDC power input
- External I/O and RS-485 interface
- Automatically obtains IP address and connects to Avigilon Control Center NVMS

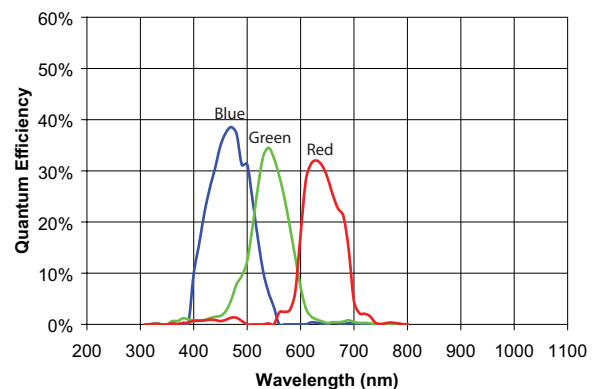

Specifications

Camera

Image Sensor	35 mm progressive scan interline transfer CCD
Active Pixels	4872 (H) x 3248 (V)
Imaging Area	36.1 mm (H) x 24.0 mm (V) 1.422" (H) x 0.946" (V)
Minimum Illumination	0.1 lux (at F1.4)
Dynamic Range	65 dB
Lens Mount	EF (SLR-style bayonet)
Image Compression Method	JPEG2000
Image Rate	3 (at full resolution) 10 (at 4872 x 480)
Resolution Windowing	Down to 640 x 480 Window
Motion Detection	Selectable sensitivity and threshold
Electronic Shutter Control	Automatic, Manual (2 to 1/60000 sec)
Iris Control	Automatic, Manual
Focus Control	Automatic, Manual
Flicker Control	50 Hz, 60 Hz
White Balance	Automatic, Manual, 6 modes
External I/O Terminals	Alarm In, Alarm Out, RS-485

Bandwidth

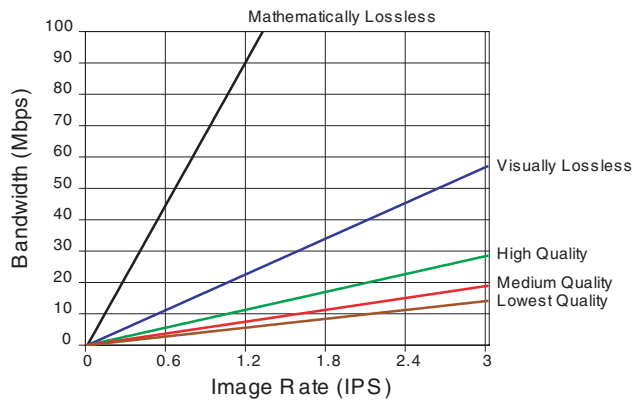

Outline Dimensions

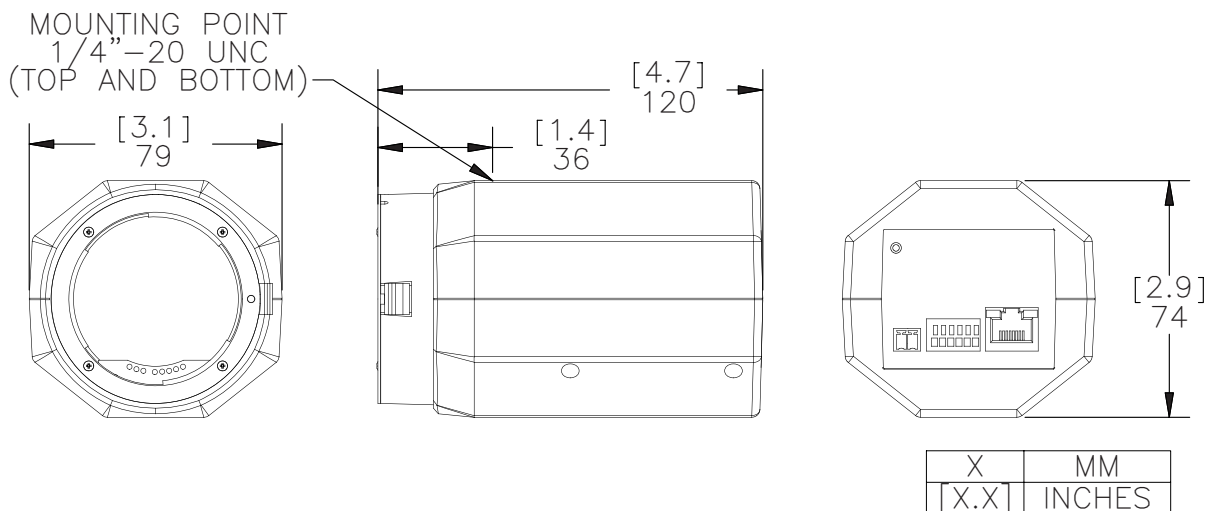

Network

Network Cabling Type	100BASE-TX, 1000BASE-T CAT5, CAT5E (for 1000BASE-T)
Connector	RJ-45
Security Protocol	SSL UDP, TCP, SOAP, DHCP, Zeroconf

Mechanical

Dimensions (LxWxH)	120 mm x 79 mm x 74 mm 4.7" x 3.1" x 2.9"
Weight	1.15 kg (2.5 lbs) without lens
Camera Mount	1/4" UNC-20 (top and bottom)

Electrical

Power Source	VDC: 12-24 V VAC: 12-24 V PoE: IEEE802.3af Class 3 compliant
Power Consumption	8 W
Power Connector	2-pin terminal block

Environmental

Operating Temperature	-10 °C to +50 °C (14 °F to 122 °F)
Storage Temperature	-10 °C to +70 °C (14 °F to 158 °F)
Humidity	20 - 80% Relative humidity (non-condensing)

Certifications

CE, Class A
FCC, Class A

Ordering Information

16MP-HD-PRO-C	16 Megapixel Color Day/Night High Definition Professional IP Camera
---------------	---